

SECTION A-A

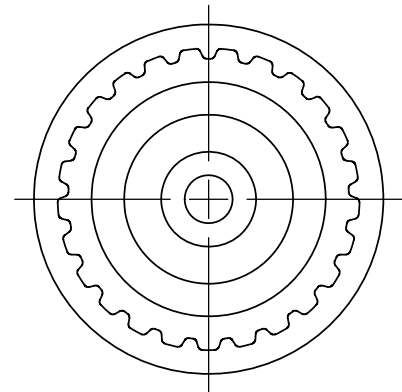
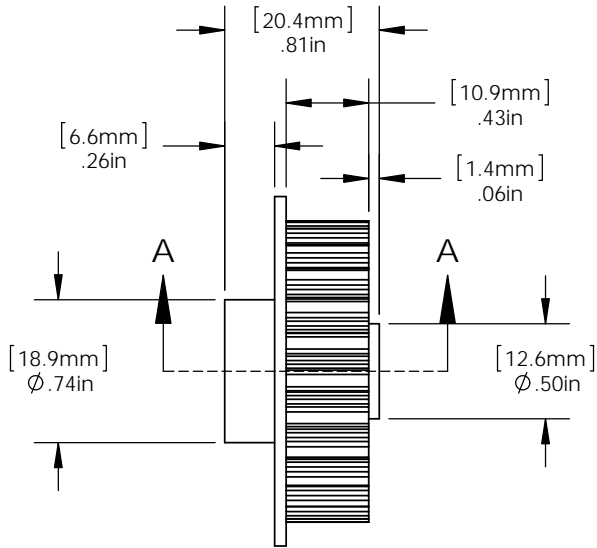
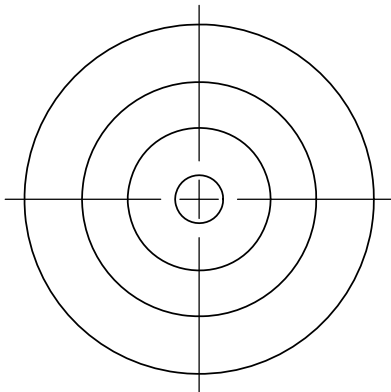
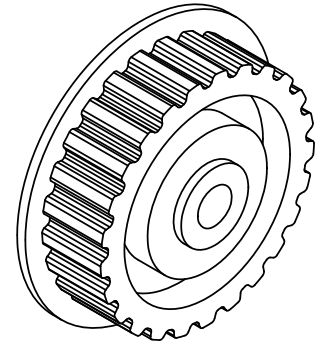
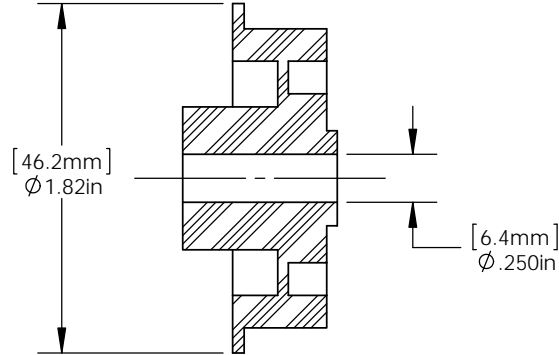

REV.	DESCRIPTION	DATE	<p>UNLESS OTHERWISE SPECIFIED: DIMENSIONS ARE IN INCHES</p> <p>TOLERANCES: FRACTIONAL ± .010 TWO PLACE DECIMAL ± .010 THREE PLACE DECIMAL ± .005 FOUR PLACE DECIMAL ± .0005 CONCENTRICITY .005 T.I.R. MAX</p> <p>BREAK SHARP EDGES .005-.010</p>	<p>25XL037 Pulley</p>		<p>Tiny-Clutch</p> <p>Helander Products, Inc. Clinton, Connecticut www.TinyClutch.com</p>		
			<p>PROPRIETARY AND CONFIDENTIAL</p> <p><small>THE INFORMATION CONTAINED IN THIS DRAWING IS THE SOLE PROPERTY OF HELANDER PRODUCTS, INC. ANY REPRODUCTION IN PART OR AS A WHOLE WITHOUT THE WRITTEN PERMISSION OF HELANDER PRODUCTS, INC. IS STRICTLY PROHIBITED.</small></p>					
				<p>MATERIAL: P.E.T.</p>	<p>SCALE: 1:1</p>	<p>DATE: 2/19/2021</p>	<p>SHEET 1 OF 1</p>	